



Tel: (450) 449-0412 ; 1-866-540-0412 Fax: (450)449-9115 ; 1-866-499-9115



SÉRIES DX SERIES

7500 VA, # DE PIÈCE / PART # : DX 7500XHU

SPÉCIFICATIONS ÉLECTRIQUES / ELECTRICAL SPECIFICATIONS

PHASE:	1	TENSION PRIMAIRE / PRIMARY VOLT.	190 - 240 X 380 - 480		PRIMARY VOLTS	CONNECT PRIMARY LINES TO	INTER-CONNECT	CONNECT SECONDARY LINES TO
	FREQ.:	50/60 Hz.	TENSION SEC. / SECONDARY VOLT.	120/240	190	H1 to H7	H1 to H6 H2 to H7	
CLASSE ISOL. INSUL. CLASS	H(180°C)	ELEV. TEMP. TEMP. RISE		208	H1 to H8	H1 to H6 H3 to H8		
				220	H1 to H9	H1 to H6 H4 to H9		
				240	H1 to H10	H1 to H6 H5 to H10		
				380	H1 to H7	H2 - H6		
				416	H1 to H8	H3 - H6		
				440	H1 to H9	H4 - H6		
				480	H1 to H10	H5 - H6		
				SECONDARY VOLT				
				120		X1 to X3 X2 to X4	X1 - X4	
				240		X2 to X3	X1 - X4	

SPÉCIFICATIONS MÉCANIQUES / MECHANICAL SPECIFICATIONS: (dimensions = pouces/Inches).

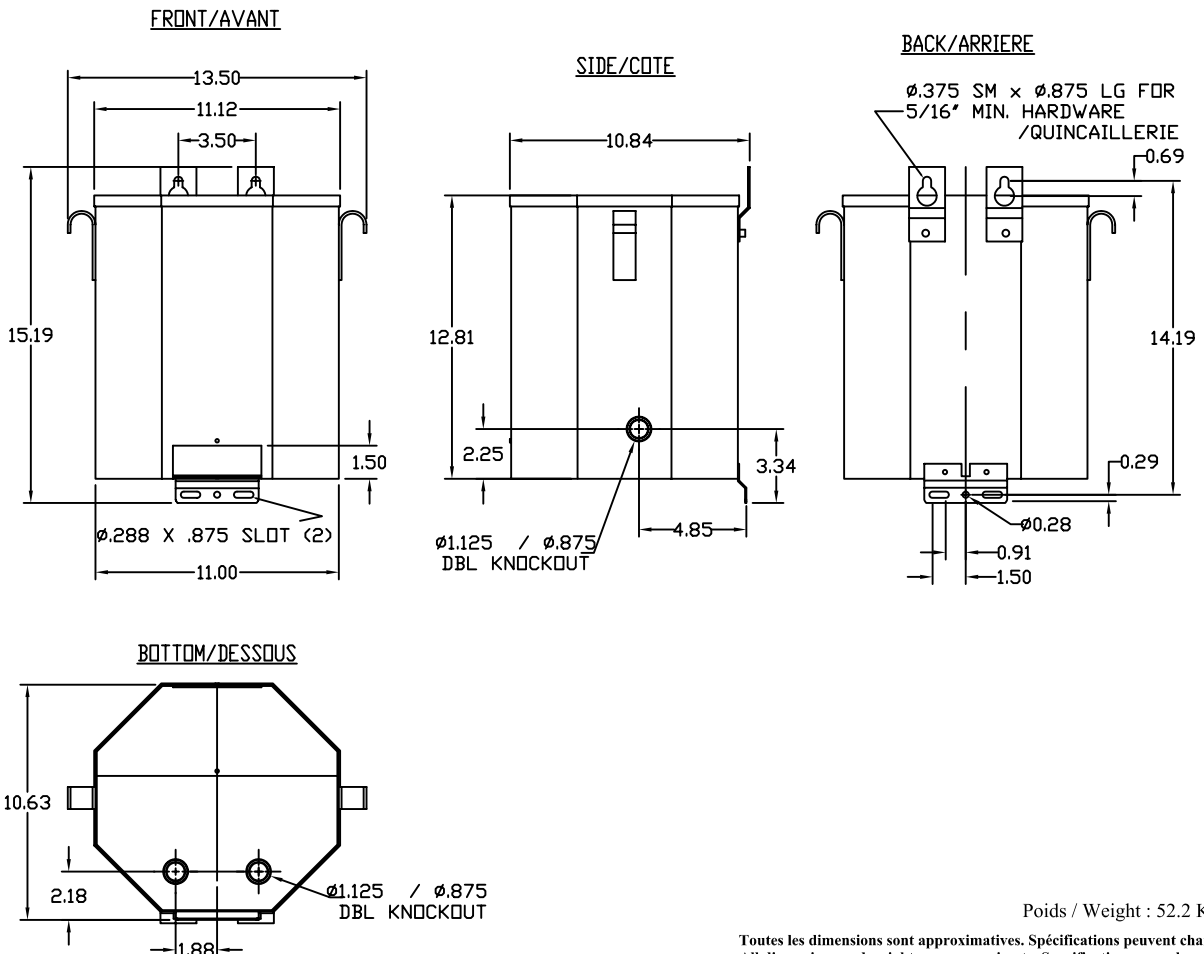

Poids / Weight : 52.2 Kg (115 lbs)

Toutes les dimensions sont approximatives. Spécifications peuvent changer sans préavis.
All dimensions and weights are approximate. Specifications may change without notice.



NUMÉRO DE MODÈLE:
MODEL NUMBER:
DX 7500XHU

ZONE	REV	REVISION	DESCRIPTION	DATE	APPROVAL APPROB.

Dessiné par: SS
Drawn by:

DWG NO. 71CUDX7500XHU

REV 00

DATE: APRIL 19th 2010

PAGE: 1 de 1