

SÉRIES EXA SERIES

750 VA, # DE PIÈCE / PART # : EXA0750XX

SPÉCIFICATIONS ÉLECTRIQUES / ELECTRICAL SPECIFICATIONS

PHASE:	<input type="text" value="1"/>
FREQ.:	<input type="text" value="60 Hz."/>
CLASSE ISOL. INSUL. CLASS	<input type="text" value="B(130°C)"/>
ELEV. TEMP. TEMP. RISE	<input 80°c")"="" type="text" value("<=""/>
NIV. DE BRUIT SOUND LEVEL	<input 40="" db."="" type="text" value("<=""/>

XX	PRI. VOLT.	SEC. VOLT.
<input type="checkbox"/> 19	120	12
<input type="checkbox"/> 20	120	24
<input type="checkbox"/> 21	120	120
<input type="checkbox"/> 22	208	24
<input type="checkbox"/> 23	208	120
<input type="checkbox"/> 24	240	24
<input type="checkbox"/> 25	240	120
<input type="checkbox"/> 26	277	24
<input type="checkbox"/> 27	277	120
<input type="checkbox"/> 28	277	240
<input type="checkbox"/> 29	347	24

XX	PRI. VOLT.	SEC. VOLT.
<input type="checkbox"/> 30	347	120
<input type="checkbox"/> 31	347	240
<input type="checkbox"/> 32	416	24
<input type="checkbox"/> 33	416	120
<input type="checkbox"/> 34	416	240
<input type="checkbox"/> 35	480	24
<input type="checkbox"/> 36	480	120
<input type="checkbox"/> 37	480	240
<input type="checkbox"/> 38	600	24
<input type="checkbox"/> 39	600	120
<input type="checkbox"/> 40	600	240

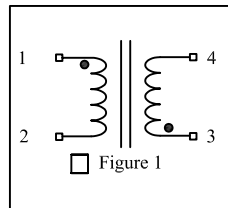

SPÉCIFICATIONS MÉCANIQUES / MECHANICAL SPECIFICATIONS: (dimensions = pouces/Inches).

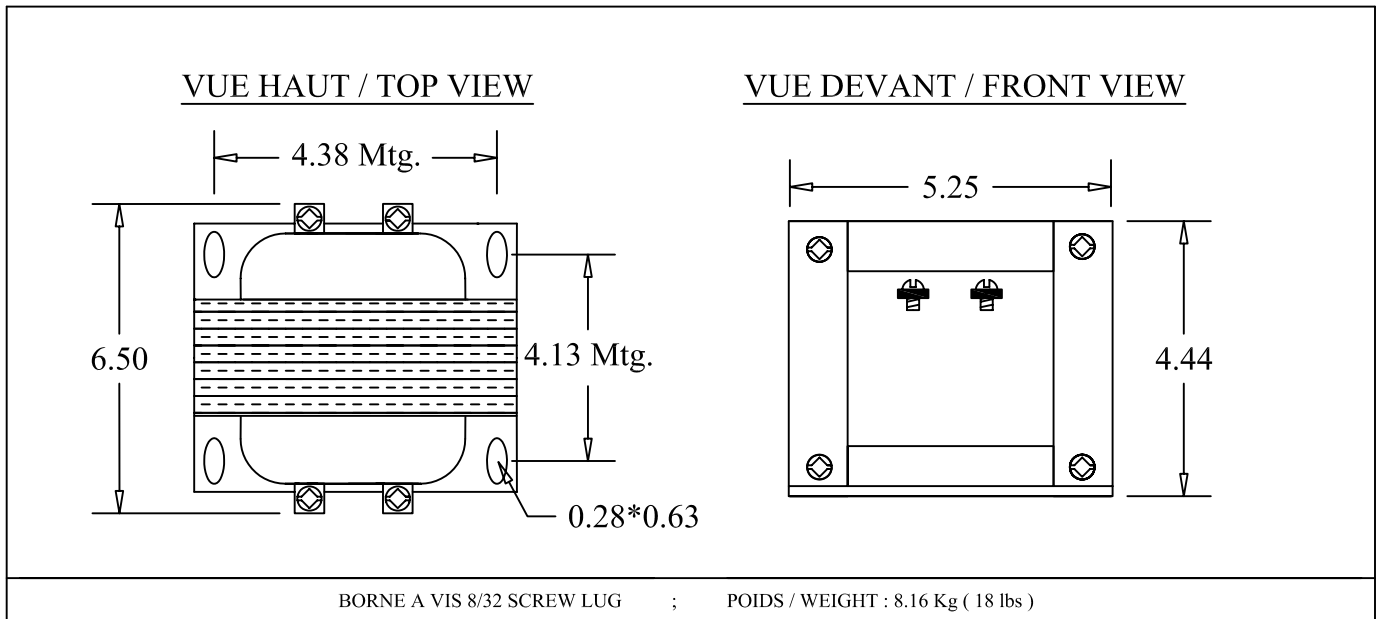

Toutes les dimensions sont approximatives. Spécifications peuvent changer sans préavis.
All dimensions and weights are approximate. Specifications may change without notice.

TRANSFAB 
magnetic solutions

NUMÉRO DE MODÈLE:
MODEL NUMBER:
EXA0750 __

ZONE	REV	REVISION	DESCRIPTION	DATE	APPROVAL APPROB.	Dessiné par: Drawn by:	SS	DWG NO. 71CUEXA0750B0	REV 04
DATE: JANUARY/30/08								PAGE: 1 de 1	